

# LA E63F dual binning

## Power TOPLED® Lens

PowerTOPLED with lens, a powerful member of the TOPLED family. Thanks to their high luminous efficacy, the LEDs are ideal for rear light clusters and indicators on vehicles and for display panels for traffic control systems.



## Applications

- Signalling

## Features:

- Package: white PLCC-4 package, colorless clear resin
- Chip technology: Thinfilm
- Typ. Radiation: 30°
- Color:  $\lambda_{\text{dom}} = 617 \text{ nm}$  (• amber)
- Corrosion Robustness Class: 3B
- ESD: 2 kV acc. to ANSI/ESDA/JEDEC JS-001 (HBM, Class 2)

---

## Ordering Information

Type	Partial Flux <sup>1)</sup> $I_F = 4 \text{ mA}$ $E_v$	Partial Flux <sup>1)</sup> $I_F = 50 \text{ mA}$ $E_v$	Ordering Code
LA E63F-V1AB-1-1+FBGB-24-1	710 ... 1800 lx	14000 ... 28000 lx	Q65111A5861

---

## Maximum Ratings

Parameter	Symbol		Values
Operating Temperature	$T_{op}$	min. max.	-40 °C 100 °C
Storage Temperature	$T_{stg}$	min. max.	-40 °C 100 °C
Junction Temperature	$T_j$	max.	125 °C
Forward current $T_s = 25\text{ °C}$	$I_F$	max.	70 mA
Surge Current $t \leq 10\text{ }\mu\text{s}$ ; $D = 0.005$ ; $T_s = 25\text{ °C}$	$I_{FS}$	max.	100 mA
Reverse voltage <sup>2)</sup> $T_s = 25\text{ °C}$	$V_R$	max.	12 V
ESD withstand voltage acc. to ANSI/ESDA/JEDEC JS-001 (HBM, Class 2)	$V_{ESD}$		2 kV

## Characteristics

$I_F = 50 \text{ mA}$ ;  $T_S = 25 \text{ °C}$

Parameter	Symbol		Values
Peak Wavelength <sup>3)</sup>	$\lambda_{\text{peak}}$	typ.	624 nm
Dominant Wavelength <sup>3)</sup> $I_F = 50 \text{ mA}$	$\lambda_{\text{dom}}$	min.	612 nm
		typ.	617 nm
		max.	624 nm
Spectral Bandwidth at 50% $I_{\text{rel,max}}$	$\Delta\lambda$	typ.	18 nm
Viewing angle at 50 % $I_V$	$2\phi$	typ.	30 °
Forward Voltage <sup>4)</sup> $I_F = 50 \text{ mA}$	$V_F$	min.	1.90 V
		typ.	2.15 V
		max.	2.50 V
Reverse current <sup>2)</sup> $V_R = 12 \text{ V}$	$I_R$	typ.	0.01 $\mu\text{A}$
		max.	10 $\mu\text{A}$
Temperature Coefficient of Peak Wavelength $-10\text{°C} \leq T \leq 100\text{°C}$	$TC_{\lambda\text{peak}}$	typ.	0.14 nm / K
Real thermal resistance junction/solderpoint <sup>4)</sup>	$R_{\text{thJS real}}$	typ.	110 K / W
		max.	130 K / W
Electrical thermal resistance junction/solderpoint <sup>5)</sup> with efficiency $\eta_e = 29 \%$	$R_{\text{thJS elec.}}$	typ.	78 K / W
		max.	92 K / W

## Brightness Groups

Group	Partial Flux <sup>1)</sup> $I_F = 4 \text{ mA}$ min. $E_v$	Partial Flux <sup>1)</sup> $I_F = 4 \text{ mA}$ max. $E_v$	Luminous Flux <sup>6)</sup> $I_F = 4 \text{ mA}$ typ. $\Phi_v$
V1	710 lx	900 lx	380 mlm
V2	900 lx	1120 lx	470 mlm
AA	1120 lx	1400 lx	590 mlm
AB	1400 lx	1800 lx	750 mlm

## Brightness Groups

Group	Partial Flux <sup>1)</sup> $I_F = 50 \text{ mA}$ min. $E_v$	Partial Flux <sup>1)</sup> $I_F = 50 \text{ mA}$ max. $E_v$	Luminous Flux <sup>6)</sup> $I_F = 50 \text{ mA}$ typ. $\Phi_v$
FB	14000 lx	18000 lx	7520 mlm
GA	18000 lx	22400 lx	9490 mlm
GB	22400 lx	28000 lx	11840 mlm

## Forward Voltage Groups

Group	Forward Voltage <sup>4)</sup> $I_F = 4 \text{ mA}$ min. $V_F$	Forward Voltage <sup>4)</sup> $I_F = 4 \text{ mA}$ max. $V_F$
2A	1.65 V	1.80 V
2B	1.80 V	1.95 V

## Forward Voltage Groups

Group	Forward Voltage <sup>4)</sup> $I_F = 50 \text{ mA}$ min. $V_F$	Forward Voltage <sup>4)</sup> $I_F = 50 \text{ mA}$ max. $V_F$
3A	1.90 V	2.05 V
3B	2.05 V	2.20 V
4A	2.20 V	2.35 V
4B	2.35 V	2.50 V

## Wavelength Groups

Group	Dominant Wavelength <sup>3)</sup> $I_F = 4 \text{ mA}$ min. $\lambda_{\text{dom}}$	Dominant Wavelength <sup>3)</sup> $I_F = 4 \text{ mA}$ max. $\lambda_{\text{dom}}$
1	611 nm	624 nm

## Wavelength Groups

Group	Dominant Wavelength <sup>3)</sup> $I_F = 50 \text{ mA}$ min. $\lambda_{\text{dom}}$	Dominant Wavelength <sup>3)</sup> $I_F = 50 \text{ mA}$ max. $\lambda_{\text{dom}}$
2	612 nm	616 nm
3	616 nm	620 nm
4	620 nm	624 nm

### Relative Spectral Emission <sup>6)</sup>

$E_{rel} = f(\lambda); I_F = 50 \text{ mA}; T_S = 25 \text{ }^\circ\text{C}$

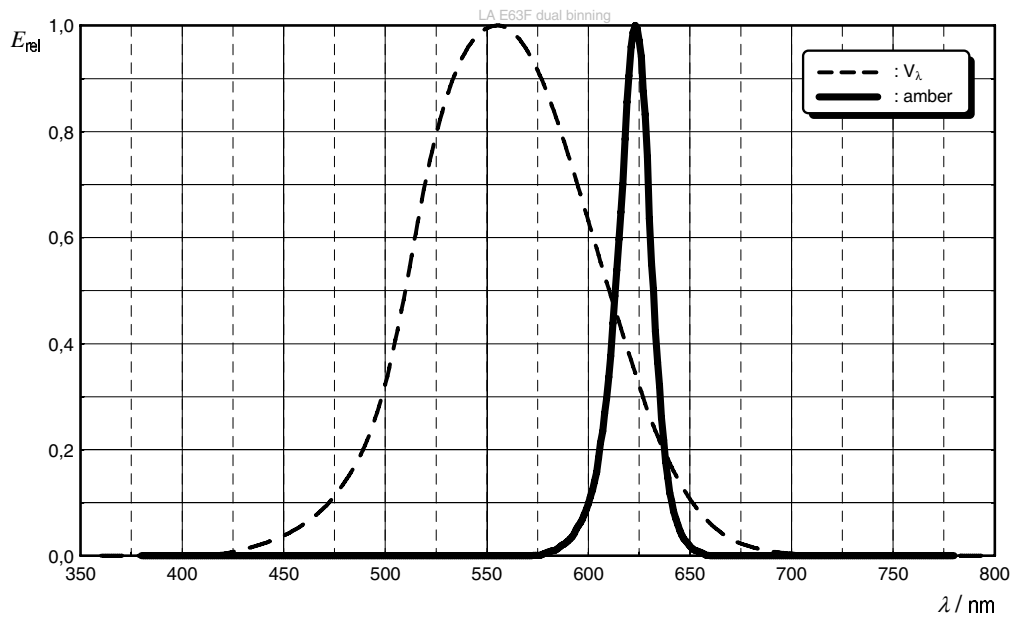

### Radiation Characteristics <sup>6)</sup>

$I_{rel} = f(\phi); T_S = 25 \text{ }^\circ\text{C}$

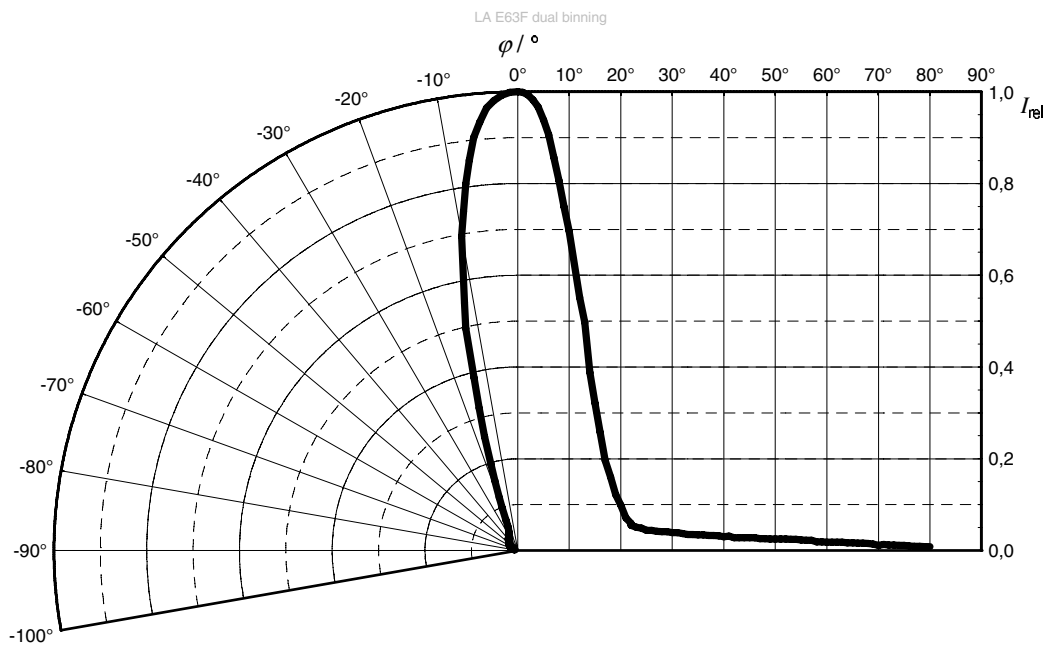

**Forward current** 6), 7)

$$I_F = f(V_F); T_S = 25\text{ °C}$$

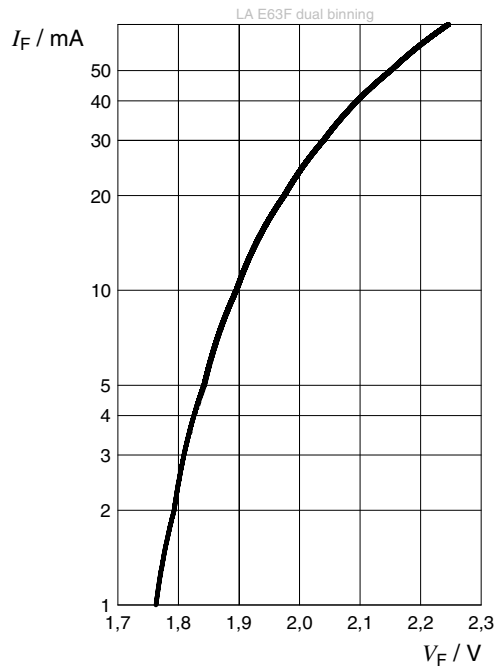

**Relative Partial Flux** 6), 7)

$$E_V / E_V(I_{F\text{ group}}) = f(I_F); T_S = 25\text{ °C}$$

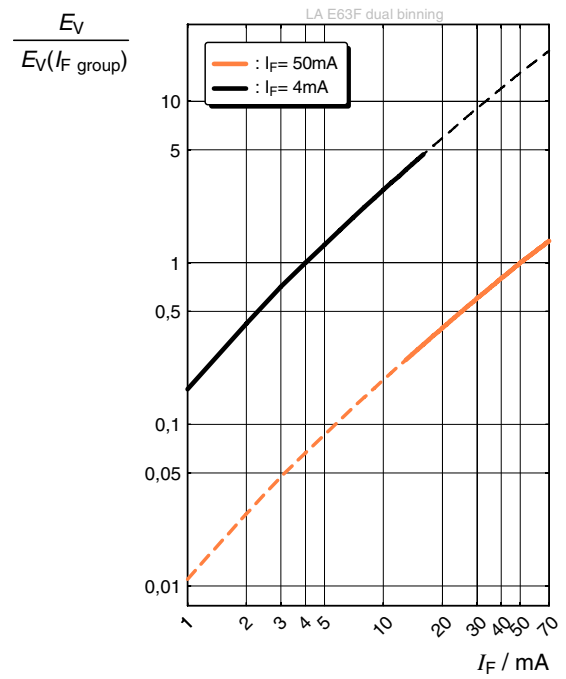



### Forward Voltage <sup>6)</sup>

$$\Delta V_F = V_F - V_F(25\text{ °C}) = f(T_j); I_F = 50\text{ mA}$$

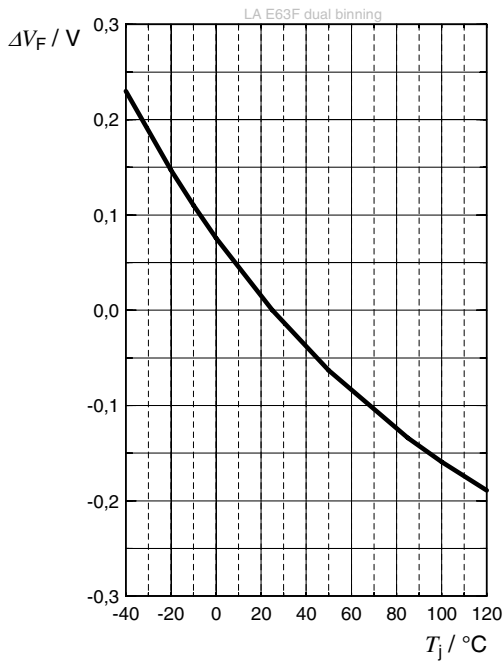

### Relative Illuminance <sup>6)</sup>

$$E_V / E_V(25\text{ °C}) = f(T_j); I_F = 50\text{ mA}$$

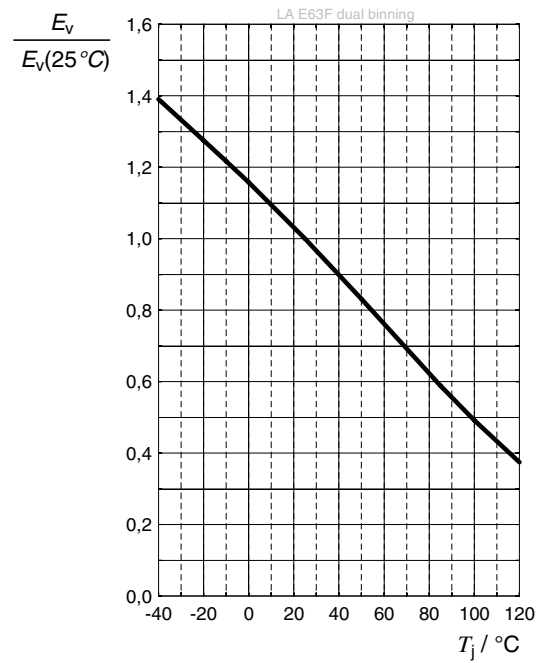

### Dominant Wavelength <sup>6)</sup>

$$\lambda_{\text{dom}} = f(T_j); I_F = 50\text{ mA}$$

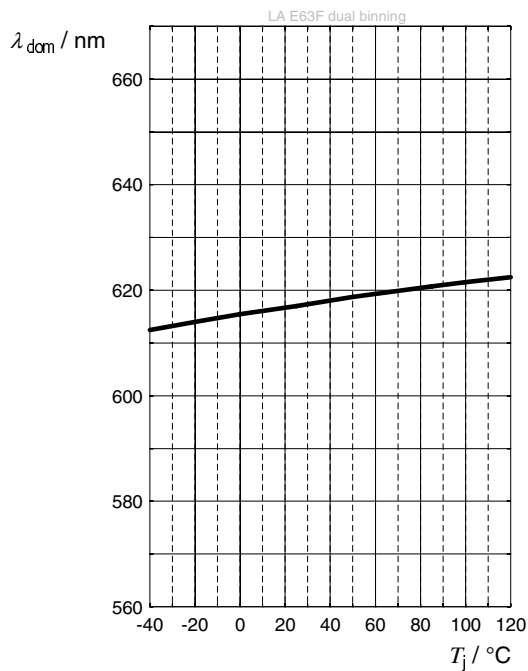

### Max. Permissible Forward Current

$I_F = f(T)$

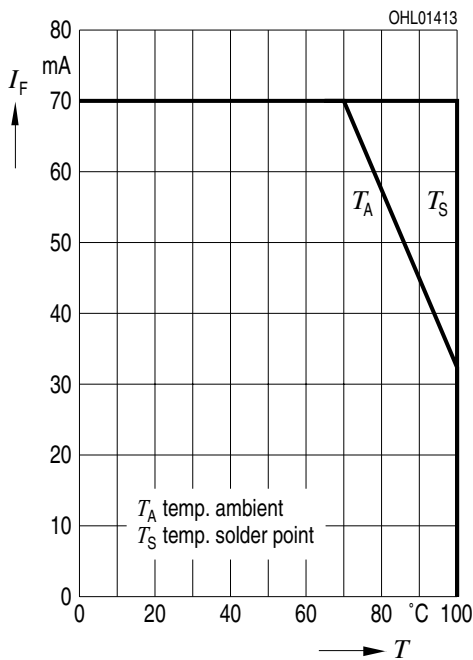

### Permissible Pulse Handling Capability

$I_F = f(t_p)$ ; D: Duty cycle;  $T_A = 25\text{ °C}$

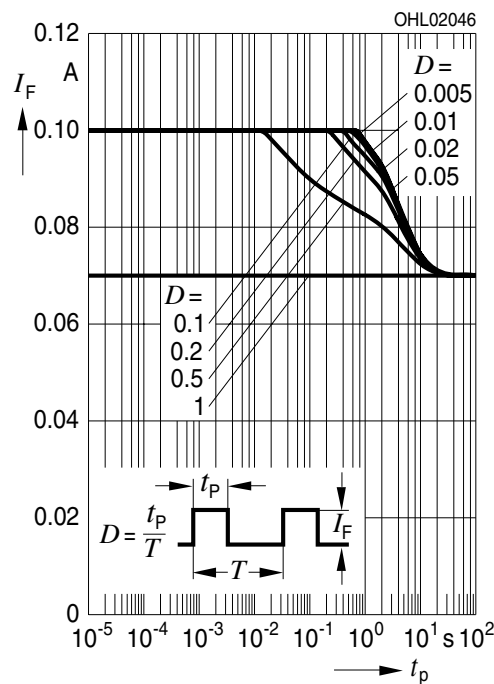

### Permissible Pulse Handling Capability

$I_F = f(t_p)$ ; D: Duty cycle;  $T_A = 85\text{ °C}$

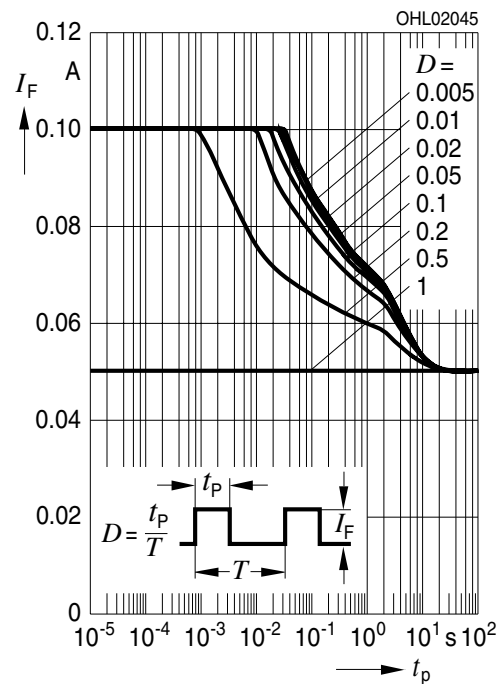

## Dimensional Drawing <sup>8)</sup>

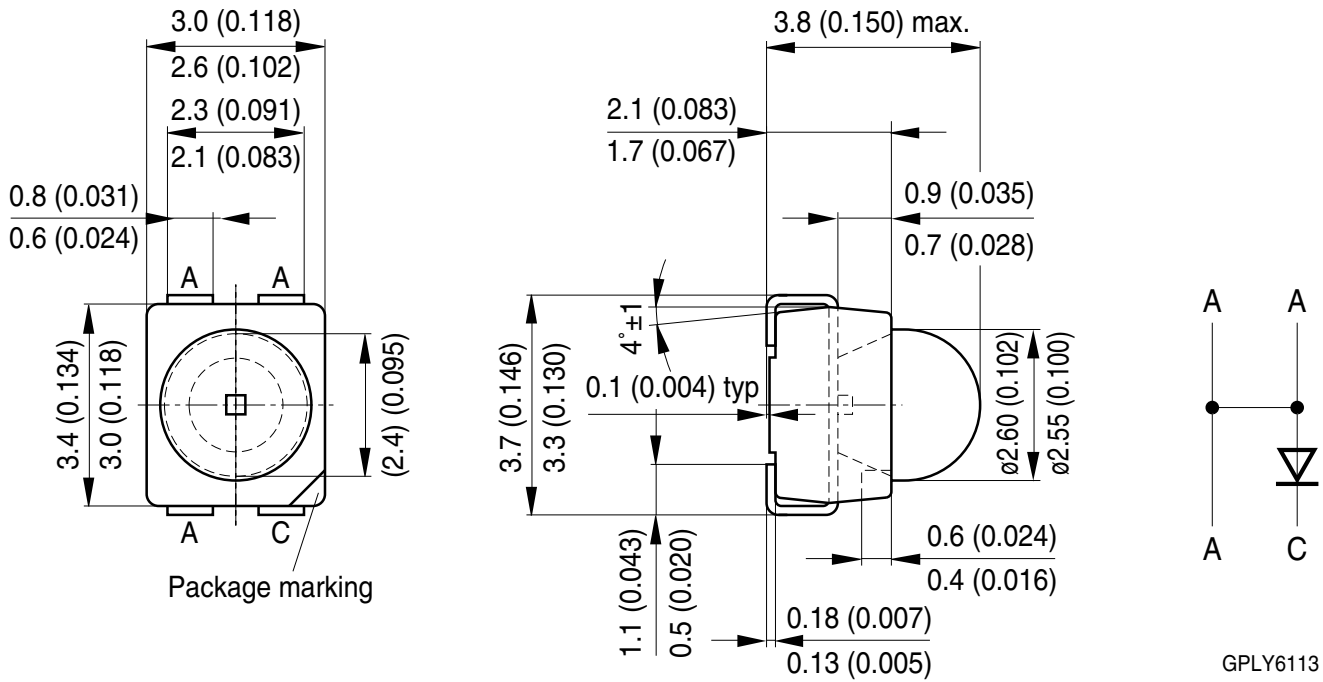

GPLY6113

**Approximate Weight:** 38.0 mg

**Package marking:** Cathode

**Corrosion test:** Class: 3B

Test condition: 40°C / 90 % RH / 15 ppm H<sub>2</sub>S / 14 days (stricter than IEC 60068-2-43)

## Recommended Solder Pad <sup>8)</sup>

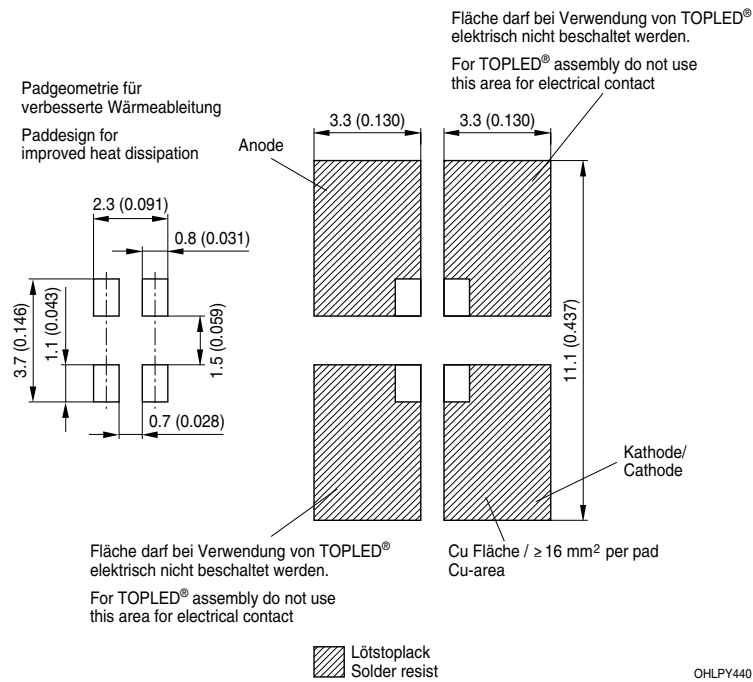

For superior solder joint connectivity results we recommend soldering under standard nitrogen atmosphere. Package not suitable for ultra sonic cleaning.

## Reflow Soldering Profile

Product complies to MSL Level 2 acc. to JEDEC J-STD-020E



Profile Feature	Symbol	Pb-Free (SnAgCu) Assembly			Unit
		Minimum	Recommendation	Maximum	
Ramp-up rate to preheat <sup>*)</sup> 25 °C to 150 °C			2	3	K/s
Time $t_s$ $T_{Smin}$ to $T_{Smax}$	$t_s$	60	100	120	s
Ramp-up rate to peak <sup>*)</sup> $T_{Smax}$ to $T_p$			2	3	K/s
Liquidus temperature	$T_L$		217		°C
Time above liquidus temperature	$t_L$		80	100	s
Peak temperature	$T_p$		245	250	°C
Time within 5 °C of the specified peak temperature $T_p - 5$ K	$t_p$	10	20	30	s
Ramp-down rate* $T_p$ to 100 °C			3	4	K/s
Time 25 °C to $T_p$				480	s

All temperatures refer to the center of the package, measured on the top of the component

\* slope calculation  $DT/Dt$ :  $Dt$  max. 5 s; fulfillment for the whole T-range

**Taping** <sup>8)</sup>

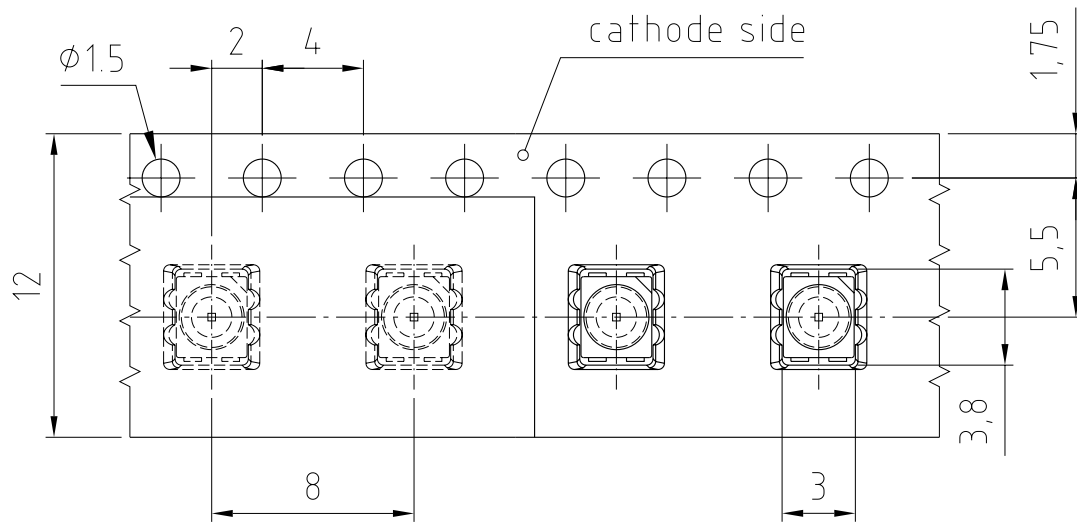

C63062-A3722-B01-02

**Tape and Reel** <sup>9)</sup>



**Reel dimensions [mm]**

A	W	N <sub>min</sub>	W <sub>1</sub>	W <sub>2max</sub>	Pieces per PU
330 mm	12 + 0.3 / - 0.1	60	12.4 + 2	18.4	2000

## Barcode-Product-Label (BPL)

**OSRAM Opto Semiconductors** LX XXXX    BIN1: XX-XX-X-XXX-X

RoHS Compliant

(6P) BATCH NO: 1234567890 ML Temp    ST  
X    XXX °C X

(1T) LOT NO: 1234567890 (9D) D/C: 1234

(X) PROD NO: 123456789(Q)QTY: 9999 (G) GROUP: XX-XX-X-X

Pack: RXX  
DEMY    XXX  
X\_X123\_1234.1234 X



OHA04563

## Dry Packing Process and Materials <sup>8)</sup>



OHA00539

Moisture-sensitive product is packed in a dry bag containing desiccant and a humidity card according JEDEC-STD-033.



## Transportation Packing and Materials <sup>8)</sup>



### Dimensions of transportation box in mm

Width	Length	Height
349 ± 5 mm	349 ± 5 mm	33 ± 5 mm

## Type Designation System

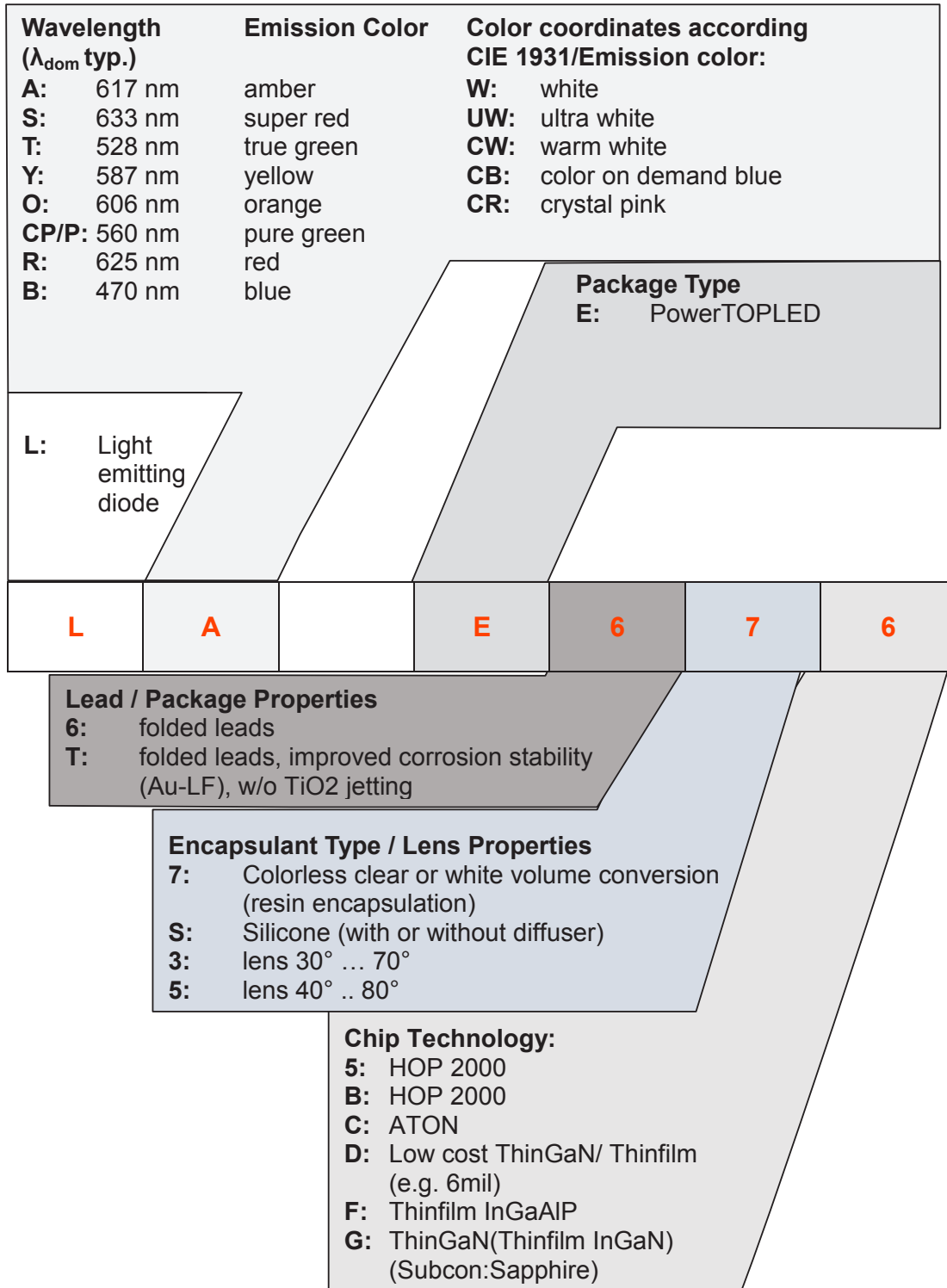

## Schematic test method for partial flux measurement

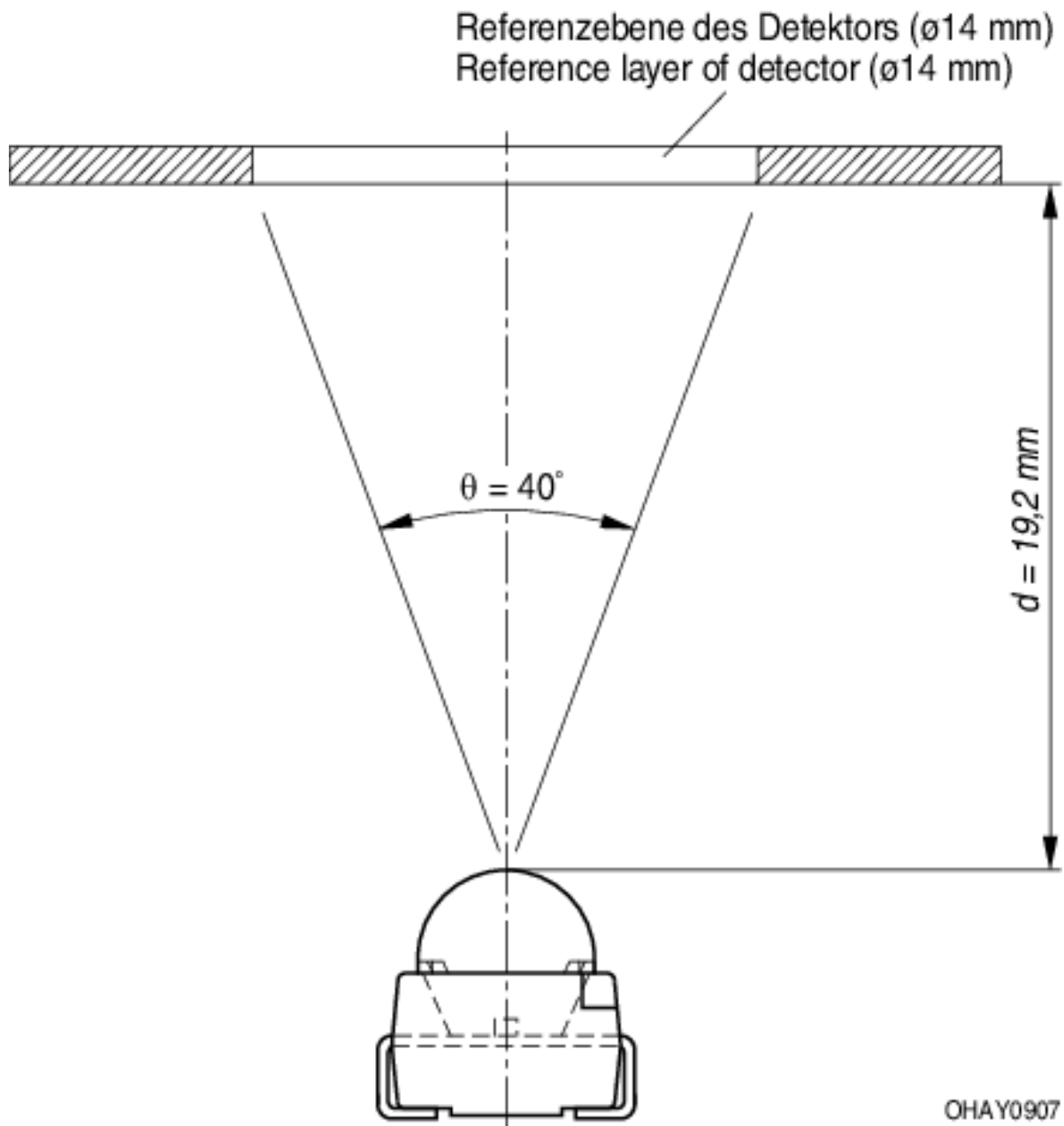

## Notes

The evaluation of eye safety occurs according to the standard IEC 62471:2006 (photo biological safety of lamps and lamp systems). Within the risk grouping system of this IEC standard, the device specified in this data sheet falls into the class **exempt group (exposure time 10000 s)**. Under real circumstances (for exposure time, conditions of the eye pupils, observation distance), it is assumed that no endangerment to the eye exists from these devices. As a matter of principle, however, it should be mentioned that intense light sources have a high secondary exposure potential due to their blinding effect. When looking at bright light sources (e.g. headlights), temporary reduction in visual acuity and afterimages can occur, leading to irritation, annoyance, visual impairment, and even accidents, depending on the situation.

Subcomponents of this device contain, in addition to other substances, metal filled materials including silver. Metal filled materials can be affected by environments that contain traces of aggressive substances. Therefore, we recommend that customers minimize device exposure to aggressive substances during storage, production, and use. Devices that showed visible discoloration when tested using the described tests above did show no performance deviations within failure limits during the stated test duration. Respective failure limits are described in the IEC60810.

For further application related informations please visit [www.osram-os.com/appnotes](http://www.osram-os.com/appnotes)

## Disclaimer

### Disclaimer

Language english will prevail in case of any discrepancies or deviations between the two language wordings.

### Attention please!

The information describes the type of component and shall not be considered as assured characteristics. Terms of delivery and rights to change design reserved. Due to technical requirements components may contain dangerous substances.

For information on the types in question please contact our Sales Organization.

If printed or downloaded, please find the latest version on the OSRAM OS website.

### Packing

Please use the recycling operators known to you. We can also help you – get in touch with your nearest sales office.

By agreement we will take packing material back, if it is sorted. You must bear the costs of transport. For packing material that is returned to us unsorted or which we are not obliged to accept, we shall have to invoice you for any costs incurred.

### Product safety devices/applications or medical devices/applications

OSRAM OS components are not developed, constructed or tested for the application as safety relevant component or for the application in medical devices.

In case Buyer – or Customer supplied by Buyer– considers using OSRAM OS components in product safety devices/applications or medical devices/applications, Buyer and/or Customer has to inform the local sales partner of OSRAM OS immediately and OSRAM OS and Buyer and /or Customer will analyze and coordinate the customer-specific request between OSRAM OS and Buyer and/or Customer.

## Glossary

- 1) **Brightness:** Brightness values are measured during a current pulse of typically 25 ms, with an internal reproducibility of  $\pm 8\%$  and an expanded uncertainty of  $\pm 11\%$  (acc. to GUM with a coverage factor of  $k = 3$ ).
- 2) **Reverse Operation:** Reverse Operation of 10 hours is permissible in total. Continuous reverse operation is not allowed.
- 3) **Wavelength:** The wavelength is measured at a current pulse of typically 25 ms, with an internal reproducibility of  $\pm 0.5$  nm and an expanded uncertainty of  $\pm 1$  nm (acc. to GUM with a coverage factor of  $k = 3$ ).
- 4) **Forward Voltage:** The forward voltage is measured during a current pulse of typically 8 ms, with an internal reproducibility of  $\pm 0.05$  V and an expanded uncertainty of  $\pm 0.1$  V (acc. to GUM with a coverage factor of  $k = 3$ ).
- 5) **Thermal Resistance:**  $R_{th\ max}$  is based on statistic values ( $6\sigma$ ).
- 6) **Typical Values:** Due to the special conditions of the manufacturing processes of semiconductor devices, the typical data or calculated correlations of technical parameters can only reflect statistical figures. These do not necessarily correspond to the actual parameters of each single product, which could differ from the typical data and calculated correlations or the typical characteristic line. If requested, e.g. because of technical improvements, these typ. data will be changed without any further notice.
- 7) **Characteristic curve:** In the range where the line of the graph is broken, you must expect higher differences between single devices within one packing unit.
- 8) **Tolerance of Measure:** Unless otherwise noted in drawing, tolerances are specified with  $\pm 0.1$  and dimensions are specified in mm.
- 9) **Tape and Reel:** All dimensions and tolerances are specified acc. IEC 60286-3 and specified in mm.

Published by OSRAM Opto Semiconductors GmbH EU RoHS and China RoHS compliant product  
Leibnizstraße 4, D-93055 Regensburg  
www.osram-os.com © All Rights Reserved.



此产品符合欧盟 RoHS 指令的要求；  
按照中国的相关法规和标准，不含有毒有害物质或元素。